

Acer Projector

P1560Bi/D751Ei/EV-F71Ki/X1525Pi/DX531Ei/
BS-531K/P1560BTi/H6535Bi/H6535BTi/
F1P1901/

P1360WBi/D721Ei/EV-W71Ki/X1325WPi/
DX431Ei/BS-331K/P1360WBTi/FWX1902/

P1260Bi/D711Ei/EV-X71Ki/X1225Pi/
DX231Ei/BS-131K/P1260BTi/FNX1903/

P1160Bi/D701Ei/EV-S71Ki/X1125Pi/DX131Ei/
BS-031K/P1160BTi/FSV1904

User's Guide

Copyright © 2019. Acer Incorporated.
All Rights Reserved.

Acer Projector User's Guide
Original Issue: 12/2019

Changes may be made periodically to the information in this publication without obligation to notify any person of such revisions or changes. Such changes will be incorporated in new editions of this manual or supplementary documents and publications. This company makes no representations or warranties, either expressed or implied, with respect to the contents hereof and specifically disclaims the implied warranties of merchantability or fitness for a particular purpose.

Record the model number, serial number, purchase date and place of purchase information in the space provided below. The serial number and model number are recorded on the label affixed to your projector. All correspondence concerning your unit should include the serial number, model number and purchase information.

No part of this publication may be reproduced, stored in a retrieval system, or transmitted, in any form or by any means, electronically, mechanically, by photocopy, recording or otherwise, without the prior written permission of Acer Incorporated.

Model number: _____

Serial number: _____

Date of purchase: _____

Place of purchase: _____

Acer and the Acer logo are registered trademarks of Acer Incorporated. Other companies' product names or trademarks are used herein for identification purposes only and belong to their respective companies.

"HDMI™, the HDMI logo and High-Definition Multimedia Interface are trademarks or registered trademarks of HDMI Licensing LLC."



Information for your safety and comfort

Read these instructions carefully. Keep this document for future reference. Follow all warnings and instructions marked on the product.

Turning the product off before cleaning

Unplug this product from the wall outlet before cleaning. Do not use liquid cleaners or aerosol cleaners. Use a damp cloth for cleaning.

Caution for plug as disconnecting device

Observe the following guidelines when connecting and disconnecting power to the external power supply unit:

- Install the power supply unit before connecting the power cord to the AC power outlet.
- Unplug the power cord before removing the power supply unit from the projector.
- If the system has multiple sources of power, disconnect power from the system by unplugging all power cords from the power supplies.

Caution for Accessibility

Be sure that the power outlet you plug the power cord into is easily accessible and located as close to the equipment operator as possible. When you need to disconnect power to the equipment, be sure to unplug the power cord from the electrical outlet.



Warnings!

- Do not use this product near water.
- Do not place this product on an unstable cart, stand or table. If the product falls, it could be seriously damaged.
- Slots and openings are provided for ventilation to ensure reliable operation of the product and to protect it from overheating. These openings must not be blocked or covered. The openings should never be blocked by placing the product on a bed, sofa, rug or other similar surface.
- This product should never be placed near or over a radiator or heat register, or in a built-in installation unless proper ventilation is provided.
- Never push objects of any kind into this product through cabinet slots as they may touch dangerous voltage points or short-out parts that could result in a fire or electric shock. Never spill liquid of any kind onto or into the product.
- To avoid damage of internal components and to prevent battery leakage, do not place the product on a vibrating surface.

- Never use it under sporting, exercising, or any vibrating environment which will probably cause unexpected short current or damage rotor devices, lamp.

Using electrical power

- This product should be operated from the type of power indicated on the marking label. If you are not sure of the type of power available, consult your dealer or local power company.
- Do not allow anything to rest on the power cord. Do not locate this product where people will walk on the cord.
- If an extension cord is used with this product, make sure that the total ampere rating of the equipment plugged into the extension cord does not exceed the extension cord ampere rating. Also, make sure that the total rating of all products plugged into the wall outlet does not exceed the fuse rating.
- Do not overload a power outlet, strip or receptacle by plugging in too many devices. The overall system load must not exceed 80% of the branch circuit rating. If power strips are used, the load should not exceed 80% of the power strip's input rating.
- This product's AC adapter is equipped with a three-wire grounded plug. The plug only fits in a grounded power outlet. Make sure the power outlet is properly grounded before inserting the AC adapter plug. Do not insert the plug into a non-grounded power outlet. Contact your electrician for details.



Warning! The grounding pin is a safety feature. Using a power outlet that is not properly grounded may result in electric shock and/or injury.



Note: The grounding pin also provides good protection from unexpected noise produced by other nearby electrical devices that may interfere with the performance of this product.

- Use the product only with the supplied power supply cord set. If you need to replace the power cord set, make sure that the new power cord meets the following requirements: detachable type, UL listed/CSA certified, VDE approved or its equivalent, 4.5 meters (15 feet) maximum length.

Product servicing

Do not attempt to service this product yourself, as opening or removing covers may expose you to dangerous voltage points or other risks. Refer all servicing to qualified service personnel.

Unplug this product from the wall outlet and refer servicing to qualified service personnel when:

- the power cord or plug is damaged, cut or frayed
- liquid was spilled into the product
- the product was exposed to rain or water
- the product has been dropped or the case has been damaged
- the product exhibits a distinct change in performance, indicating a need for service
- the product does not operate normally after following the operating instructions



.....

Note: Adjust only those controls that are covered by the operating instructions, since improper adjustment of other controls may result in damage and will often require extensive work by a qualified technician to restore the product to normal condition.



.....

Warning! For safety reasons, do not use non-compliant parts when adding or changing components. Consult your reseller for purchase options.

Your device and its enhancements may contain small parts. Keep them out of the reach of small children.

Additional safety information

- Do not look into the projector's lens when the lamp is on. The bright may hurt your eyes.
- Turn on the projector first and then signal sources
- Do not place the product in following environments:
 - Space that is poorly ventilated or confined. At least 50cm clearance from walls and free flow of air around the projector is necessary.
 - Locations where temperatures may become excessively high, such as inside of a car with all windows rolled up.
 - Locations where excessive humidity, dust, or cigarette smoke may contaminate optical components, shortening the life span and darkening the image.
 - Locations near fire alarms.
 - Locations with an ambient temperature above 40 oC/104 oF.
 - Locations where the altitudes are higher than 10000 feet.
- Unplug immediately if there is something wrong with your projector. Do not operate if smoke, strange noise or odor comes out of your projector. It might cause fire or electric shock. In this case, unplug immediately and contact your dealer.
- Do not keep using this product to break or drop it. In this case contact your dealer for inspection.
- Do not face the projector lens to the sun. It can lead to fire.
- When switching the projector off, suggest to ensure the projector completes its cooling cycle before disconnecting power.
- Do not frequently turn off the main power abruptly or unplug the projector during operation. The best way is to wait for the fan to turn off before turning main power off..

- Do not touch air outlet grille and bottom plate which becomes hot.
- Do not look into the air outlet grille when projector is operating. It may hurt your eyes.
- Always open the lens shutter or remove the lens cap when the projector is on.
- Do not block the projector lens with any object when the projector is under operation as this could cause the object to become heated and deformed or even cause a fire. To temporarily turn off the lamp, press HIDE on the remote control.
- The lamp becomes extremely hot during operation. Allow the projector to cool for approximately 45 minutes prior to removing the lamp assembly for replacement.
- Do not operate lamps beyond the rated lamp life. It could cause it to break on rare occasions.
- Never replace the lamp assembly or any electronic components unless the projector is unplugged.
- The product will detect the life of the lamp itself. Please be sure to change the lamp when is showing warning message.
- When changing the lamp, please allow unit to cool down, and follow all changing instructions.
- Reset the "Lamp Hour Reset" function from the Onscreen display "Management > Lamp Settings" menu after replacing the lamp module.
- Do not attempt to disassemble this projector. There are dangerous high voltages inside which may hurt you. The only user serviceable part is the lamp which has its own removable cover. Refer servicing only to suitable qualified professional service personnel.
- Do not stand the projector on end vertically. It may cause the projector to fall over, causing injury or damage.
- This product is capable of displaying inverted images for ceiling mount installation. Only use acer ceiling mount kit for mounting the projector and ensure it is securely installed.
- The projector should be placed in a horizontal way by means of desktop or ceiling mount mode only, and its tilt angles should not exceed 20 degrees, otherwise it would cause dramatical decrease of lamp life or severe safety concern of system malfunction.

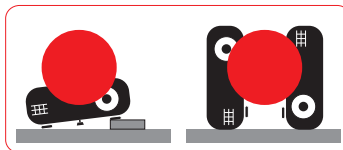
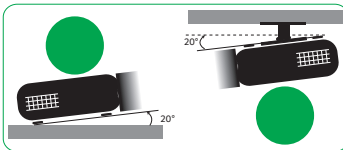

Caution for Listening

To protect your hearing, follow these instructions.

- Increase the volume gradually until you can hear clearly and comfortably.
- Do not increase the volume level after your ears have adjusted.
- Do not listen to music at high volumes for extended periods.
- Do not increase the volume to block out noisy surroundings.
- Decrease the volume if you can't hear people speaking near you.

Disposal instructions

Do not throw this electronic device into the trash when discarding. To minimize pollution and ensure utmost protection of the global environment, please recycle. For more information on the Waste from Electrical and Electronics Equipment (WEEE) regulations, visit

<http://www.acer-group.com/public/Sustainability/sustainability01.htm>



Mercury advisory

For projectors or electronic products containing an LCD/CRT monitor or display:

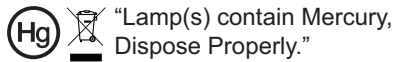

Lamp(s) inside this product contain mercury and must be recycled or disposed of according to local, state or federal laws. For more information, contact the Electronic Industries Alliance at www.eiae.org. For lamp-specific disposal information, check www.lamprecycle.org

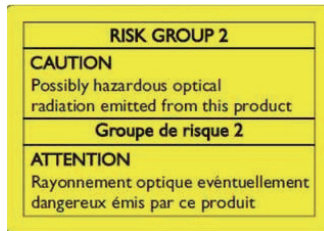

Do not stare into the beam, RG2

"As with any bright source, do not stare into the direct beam, RG2 IEC 62471-5:2015"

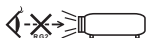

First things first

Usage Notes

Do:

- Turn off the product before cleaning.
- Use a soft cloth moistened with mild detergent to clean the display housing.
- Disconnect the power plug from AC outlet if the product is not being used for a long period of time.

Don't:

- Block the slots and openings on the unit provided for ventilation.
- Use abrasive cleaners, waxes or solvents to clean the unit.
- Use under the following conditions:
 - In extremely hot, cold or humid environments.
 - In areas susceptible to excessive dust and dirt.
 - Near any appliance that generates a strong magnetic field.
 - Place In direct sunlight.

Precautions

Follow all warnings, precautions and maintenance as recommended in this user's guide to maximize the life of your unit.



Warning:

- Do not look into the projector's lens when the lamp is on. The bright light may hurt your eyes.
- To reduce the risk of fire or electric shock, do not expose this product to rain or moisture.
- Please do not open or disassemble the product as this may cause electric shock.
- When changing the lamp, please allow unit to cool down, and follow all changing instructions.
- This product will detect the life of the lamp itself. Please be sure to change the lamp when it shows warning messages.
- Reset the "Lamp Hour Reset" function from the Onscreen display "Management > Lamp Settings" menu after replacing the lamp module.
- When switching the projector off, please ensure the projector completes its cooling cycle before disconnecting power.
- Turn on the projector first and then the signal sources.
- Do not use lens cap when projector is in operation.
- When the lamp reaches the end of its life, it will burn out and may make a loud popping sound. If this happens, the projector will not turn back on until the lamp module has been replaced. To replace the lamp, follow the procedures listed under "Replacing the Lamp".

Information for your safety and comfort	iii
First things first	viii
Usage Notes	viii
Precautions	viii
Introduction	1
Product Features	1
Package Overview	2
Projector Overview	3
Projector Outlook	3
Control Panel	4
Remote Control Layout	5
Getting Started	7
Connecting the Projector	7
Turning the Projector On/Off	8
Turning on the Projector	8
Turning the projector off	9
Adjusting the Projected Image	10
Adjusting the Height of Projected Image	10
How to optimize image size and distance	11
How to get a preferred image size by adjusting distance and zoom	15
User Controls	19
Onscreen Display (OSD) Menus	19
Color	20
Image	22
Source	23
Setting	23
Management	25
Information	26
Acer LAN webpage management	27
How to login in	27
System Status	28
Change Password	28

Contents

Projector Control Panel	29
Network Setting	29
Crestron Setting (optional)	29
Appendices	30
Troubleshooting	30
LED & Alarm Definition Listing	31
Replacing the Lamp	32
Ceiling Mount Installation	33
Specifications	36
Compatibility modes	38
Regulations and safety notices	40

Introduction

Product Features

This product is a single-chip DLP® projector. Outstanding features include:

- DLP® technology
- Auto/4:3/16:9/16:10 aspect ratio supported
- Enables projecting 3D content via DLP Link Technology
- Acer ColorBoost technology delivers nature's true colors for vivid, life-like images
- High brightness and contrast ratio
- Acer LumiSense technology can intelligently optimize the brightness and color saturation of projected image based on actual ambient light
- Acer BluelightShield™ reduces the exposure ratio of blue light, which can potentially cause long-term eye damage, by adjusting color hue and brightness
- Versatile display modes (Bright, Presentation, Standard, Video, User, 3D) enable optimum performance in any situation
- HDTV (480i/p, 576i/p, 720p, 1080i/p) supported
- Lower power consumption and economy (ECO) mode extends lamp life
- Acer EcoProjection Technology delivers intelligent power management approach and physical efficiency improvement
- Equipped with HDMI™ connection supporting HDCP
- Advanced digital keystone correction optimizes presentations
- Smart detection delivers quick, intelligent source detection
- Multi-language onscreen display (OSD) menus
- Manual focus projection lens zooms up to 1.2x
- 1.8X digital zoom
- Microsoft® Windows® XP, Windows 7, Windows 8.0, Windows 8.1, Windows 10, Macintosh® OS compliant



.....
Note: Functions vary depending on model definition.

Package Overview

This projector comes with all the items shown below. Check to make sure your unit is complete. Contact your dealer immediately if any thing is missing.

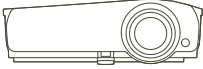

Projector



Power cord



VGA cable (option)

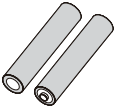

2 x Batteries



Quick start guide (projector)



Remote control



Quick start guide
(Media/Wireless function)



WirelessProjection-Kit
(option)



CastMaster-Kit
(option)

Projector Overview

Projector Outlook

Front / upper side

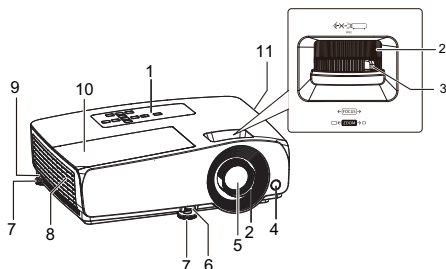

#	Description	#	Description
1	Control panel	7	Adjuster foot
2	Focus ring	8	Air outlet
3	Zoom ring	9	Security bar
4	Remote control receiver	10	Lamp cover
5	Projection lens	11	Air inlet
6	Quick-release lever		

Rear / Left side

<Rear side>

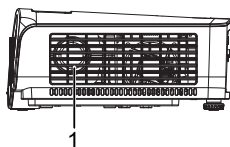

<Left side>

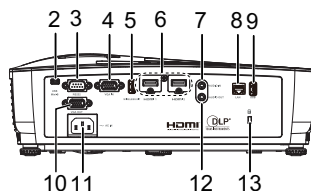

#	Description	#	Description
1	Speaker	8	LAN (RJ45 Port for 10/100M Ethernet)
2	Mini USB connector	9	USB connector (5V/1.5A)
3	RS232 connector	10	Monitor loop-through output connector (VGA OUT)
4	PC analog signal/HDTV/component video input connector (VGA IN)	11	Power socket
5	USB connector (WIRELESS KIT)	12	Audio output connector
6	HDMI input connector	13	Kensington anti-theft lock slot
7	Audio input connector		



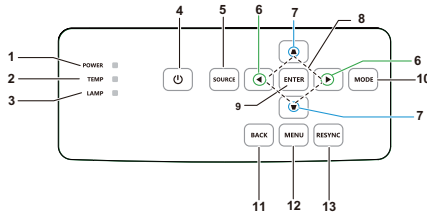

Control Panel



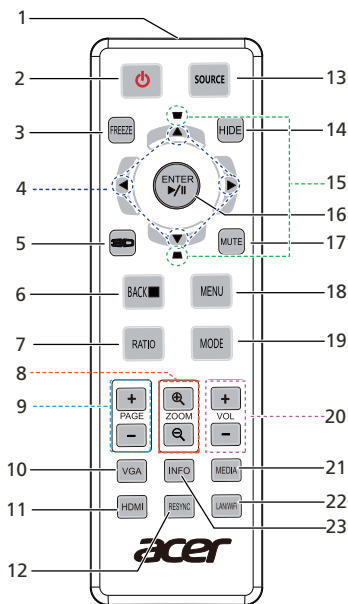

#	Icon	Function	Description
1		POWER	Power Indicator LED
2		TEMP	Temp Indicator LED
3		LAMP	Lamp Indicator LED
4		POWER	See the contents in "Turning the Projector On/ Off" section.
5		SOURCE	Changes the active source, short press the button.
6		VOLUME	Adjusts the sound level.
7		KEystone	Adjusts the image to compensate for distortion caused by tilting the projector (± 30 degrees).
8		Four directional select keys	Use up, down, left, right buttons to select items or make adjustments to your selection.
9		ENTER	Confirm your selection of items.
10		MODE	Press "MODE" to select the display mode from Bright, Presentation, Standard, Video, User 1 and User 2.
11		BACK	Go back to the previous menu or exit function.
12		MENU	Press "MENU" to launch the onscreen display (OSD) menu or exit the OSD menu.
13		RESYNC	Automatically determines the best picture timings for the displayed image

Remote Control Layout



#	Icon	Function	Description
1		Infrared transmitter	Sends signals to the projector.
2		POWER	Refer to the " Turning the Projector On/Off " section.
3		FREEZE	To pause the screen image.
4		Four directional select keys	Use up, down, left, right buttons to select items or make adjustments to your selection.
5		3D	Only available for 3D input signal.
6	BACK 	BACK STOP	Go back to the previous menu or exit function. No function.
7		RATIO	To choose the desired aspect ratio.
8		ZOOM	Zooms in or out the projector display.
9		PAGE	<ul style="list-style-type: none"> For computer mode. Use this button to select the next or previous page. This function is available when USB Ctrl connector (mini type B) is connected to a computer via a USB cable. Use this button to select the next or previous page in Media mode.

#	Icon	Function	Description
10		VGA	Press " VGA " to change source to the VGA connector.
11		HDMI	To change source to HDMI.
12		RESYNC	Automatically determines the best picture timings for the displayed image.
13		SOURCE	Changes the active source.
14		HIDE	Momentarily turns off the video. Press "HIDE" to hide the image, press again to display the image.
15		KEYSTONE	Adjusts the image to compensate for distortion caused by tilting the projector (± 30 degrees).
16	ENTER 	Enter	Confirm your selection of items.
		Play/Pause	No function.
17		MUTE	To turn on/off AV mute.
18		MENU	Press "MENU" to launch the onscreen display (OSD) menu or exit the OSD menu.
19		MODE	Press "MODE" to select the display mode from Bright, Presentation, Standard, Video, User 1 and User 2.
20		Volume UP/ Down	Increases or decreases the volume.
21		MEDIA	Press "MEDIA" to go to the home page of media mode.
22		LAN/WiFi	Press "LAN/WiFi" to go to the home page of LAN/WiFi mode.
23		INFO	Displays the status information of the projector.



.....
Note: Functions vary depending on model definition.

Getting Started

Connecting the Projector

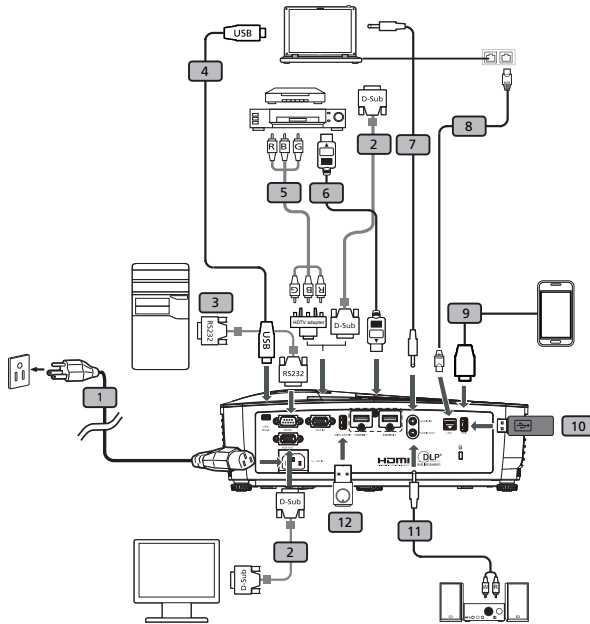

#	Description	#	Description
1	Power cord	7	Audio cable Jack/Jack
2	VGA cable	8	LAN cable
3	RS232 cable	9	USB cable for charging device
4	USB cable (mini-B to type A)	10	USB flash drive
5	Component Video to VGA (DSub) adapter cable	11	Audio cable jack/RCA
6	HDMI cable	12	Wireless dongle



Note: To ensure the projector works well with your computer, please make sure the timing of the display mode is compatible with the projector.

Note: Functions vary depending on model definition.

Note: USB cable needs powered extender if the length is over 5 m.

Turning the Projector On/Off

Turning on the Projector

- 1 Ensure that the power cord and signal cable are securely connected. The Power indicator LED will turn orange.
- 2 Turn on the projector by pressing "**Power**" button on the control panel or remote control, and the Power indicator LED will flash green.
- 3 Turn on your source (computer, notebook, video player ,etc.). The projector will detect your source automatically.
 - If the screen displays "No Signal", please make sure the signal cables are securely connected.
 - If you connect to multiple sources at the same time, use the "**Source**" button on the remote control or direct source key on the remote control to switch between inputs.

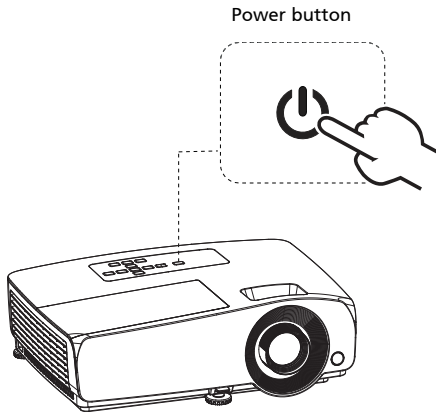

Turning the projector off

- 1 To turn the projector off, press and hold the power button. This message appears: "Press  again to Standby mode." Press the power button again.
- 2 The LED power indicator will flash orange after the projector is turned off, and the fan(s) will continue to operate to ensure that the system cools properly.
- 3 Once the system has finished cooling, the LED power indicator will stop blinking and turn solid orange to indicate standby mode.
- 4 It is now safe to unplug the power cord.



.....
Note: Whenever the projector automatically shuts down and the LED lamp indicator turns solid red, contact your local reseller or service center.

Note: Functions vary depending on model definition.

Adjusting the Projected Image

Adjusting the Height of Projected Image

The projector is equipped with elevator feet for adjusting the height of image.

- 1 Pull the quick-release lever and lift the front of the projector. Once the image is positioned where you want it, release the quick-release lever to lock the foot in position. You may also screw the front adjuster foot to change the image height.
- 2 Screw the rear adjuster feet to fine tune the horizontal angle.

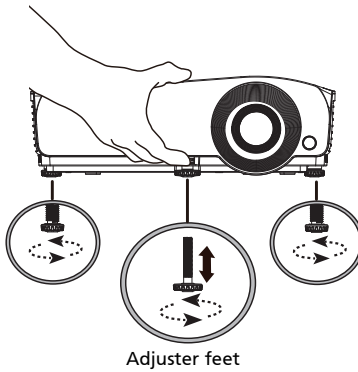

How to optimize image size and distance

- SVGA series

Consult the table below to find the optimal image sizes achievable when the projector is positioned at a desired distance from the screen.

If the projector is 2.0 m from the screen, good image quality is possible for image sizes between 42" and 50".



Note: Remind as below figure, the space of 87 cm height is required when located at 2.0 m distance.

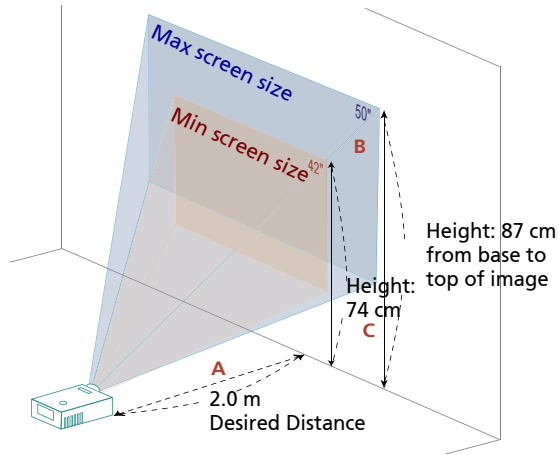

Desired Distance (m) <A>	Screen size (Min zoom)		Top	Screen size (Max zoom)		Top
	Diagonal (inch) 	W (cm) x H (cm)	From base to top of image (cm) <C>	Diagonal (inch) 	W (cm) x H (cm)	From base to top of image (cm) <C>
1.6	34	69 x 52	60	41	82 x 62	71
2	42	86 x 64	74	50	102 x 77	87
2.5	52	106 x 80	90	63	127 x 95	107
3	63	127 x 95	107	75	152 x 114	127
3.5	73	148 x 111	124	87	177 x 133	147
4	83	169 x 127	140	99	202 x 151	167
4.5	93	190 x 142	157	112	227 x 170	186
5	104	210 x 158	173	124	252 x 189	206
6	124	252 x 189	207	148	301 x 226	246
7	144	294 x 220	240	173	351 x 263	286
8	165	335 x 251	273	197	401 x 301	326
9	185	377 x 283	306	222	451 x 338	365
10	206	418 x 314	340	246	500 x 375	405
11	226	460 x 345	373	271	550 x 413	445
12.2	251	510 x 382	413	300	610 x 457	493

Zoom Ratio: 1.2x

- XGA series

Consult the table below to find the optimal image sizes achievable when the projector is positioned at a desired distance from the screen.

If the projector is 2.0 m from the screen, good image quality is possible for image sizes between 43" and 51".



Note: Remind as below figure, the space of 88 cm height is required when located at 2.0 m distance.

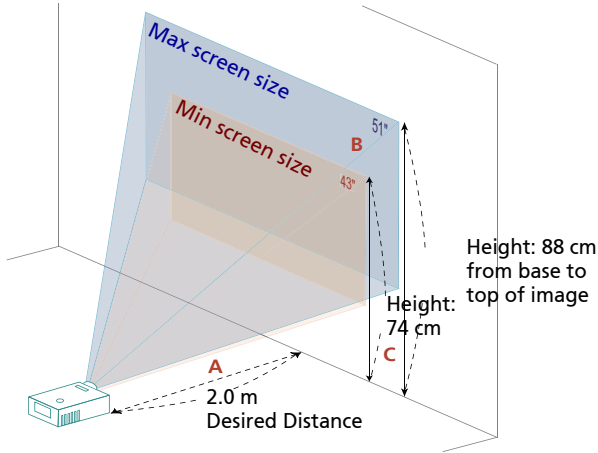

Desired Distance (m) <A>	Screen size		Top	Screen size		Top
	(Min zoom)			(Max zoom)		
	Diagonal (inch) 	W (cm) x H (cm)	From base to top of image (cm) <C>	Diagonal (inch) 	W (cm) x H (cm)	From base to top of image (cm) <C>
1.6	34	70 x 52	61	41	83 x 63	72
2	43	87 x 65	74	51	103 x 78	88
2.5	53	108 x 81	91	63	129 x 96	107
3	63	129 x 96	107	76	154 x 115	127
3.5	74	150 x 112	124	88	179 x 134	147
4	84	171 x 128	141	100	204 x 153	167
4.5	94	192 x 144	158	113	229 x 172	187
5	105	213 x 159	174	125	254 x 191	207
6	125	255 x 191	208	150	304 x 228	247
7	146	297 x 222	241	174	354 x 266	287
8	167	339 x 254	274	199	405 x 304	327
9	187	381 x 285	308	224	455 x 341	367
10	208	423 x 317	341	249	505 x 379	407
11	229	465 x 348	375	273	555 x 416	447
12.1	251	511 x 383	411	300	611 x 458	491

Zoom Ratio: 1.2x

- WXGA series

Consult the table below to find the optimal image sizes achievable when the projector is positioned at a desired distance from the screen.

If the projector is 2.0 m from the screen, good image quality is possible for image sizes between 50" and 60".



Note: Remind as below figure, the space of 89 cm height is required when located at 2.0 m distance.

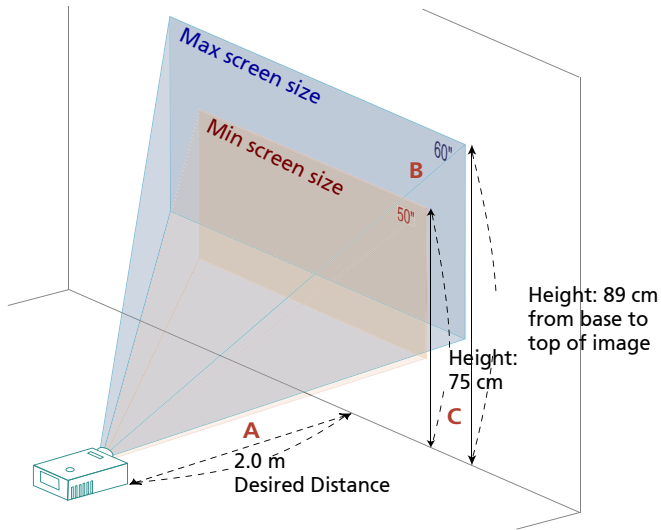

Desired Distance (m) <A>	Screen size		Top	Screen size		Top
	(Min zoom)			(Max zoom)		
	Diagonal (inch) 	W (cm) x H (cm)	From base to top of image (cm) <C>	Diagonal (inch) 	W (cm) x H (cm)	From base to top of image (cm) <C>
1.3	33	71 x 45	52	40	86 x 53	61
2	50	108 x 68	75	60	130 x 81	89
2.5	62	134 x 84	92	75	161 x 101	110
3	75	161 x 100	109	89	192 x 120	130
3.5	87	187 x 117	126	104	224 x 140	150
4	99	213 x 133	143	119	255 x 160	171
4.5	111	239 x 150	160	133	287 x 179	191
5	123	265 x 166	177	148	318 x 199	212
6	148	318 x 199	211	177	381 x 238	252
7	172	370 x 231	245	206	444 x 278	293
8	196	423 x 264	279	235	507 x 317	334
9	221	475 x 297	314	265	570 x 356	375
10.2	250	538 x 336	354	300	645 x 403	424

Zoom Ratio: 1.2x

- 1080p series

Consult the table below to find the optimal image sizes achievable when the projector is positioned at a desired distance from the screen.

If the projector is 2.0 m from the screen, good image quality is possible for image sizes between 55" and 66".



Note: Remind as below figure, the space of 93 cm height is required when located at 2.0 m distance.

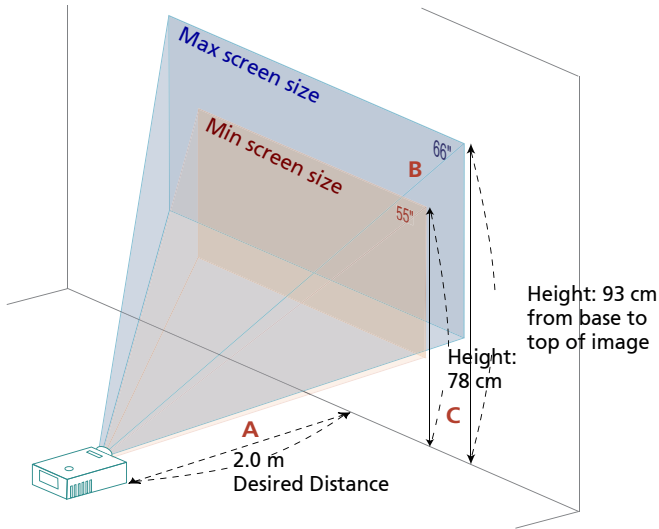

Desired Distance (m) <A>	Screen size		Top	Screen size		Top
	(Min zoom)			(Max zoom)		
	Diagonal (inch) 	W (cm) x H (cm)	From base to top of image (cm) <C>	Diagonal (inch) 	W (cm) x H (cm)	From base to top of image (cm) <C>
1.2	33	74 x 42	50	40	89 x 50	59
2	55	121 x 68	78	66	146 x 82	93
2.5	68	150 x 85	96	82	182 x 102	115
3	81	180 x 101	113	98	217 x 122	136
3.5	94	209 x 118	131	114	253 x 142	157
4	108	239 x 134	149	130	289 x 162	179
4.5	121	268 x 151	166	147	324 x 182	200
5	134	297 x 167	184	163	360 x 202	222
6	161	356 x 200	219	195	431 x 243	264
7	187	415 x 233	255	227	503 x 283	307
8	214	474 x 267	290	259	574 x 323	350
9	241	533 x 300	325	291	645 x 363	393
9.3	249	550 x 310	336	301	666 x 375	406

Zoom Ratio: 1.2x

How to get a preferred image size by adjusting distance and zoom

- SVGA series

The table below shows how to achieve a desired image size by adjusting either the position or the zoom ring.

To obtain an image size of 60" set the projector at a distance 2.4 m and 2.9 m from the screen.

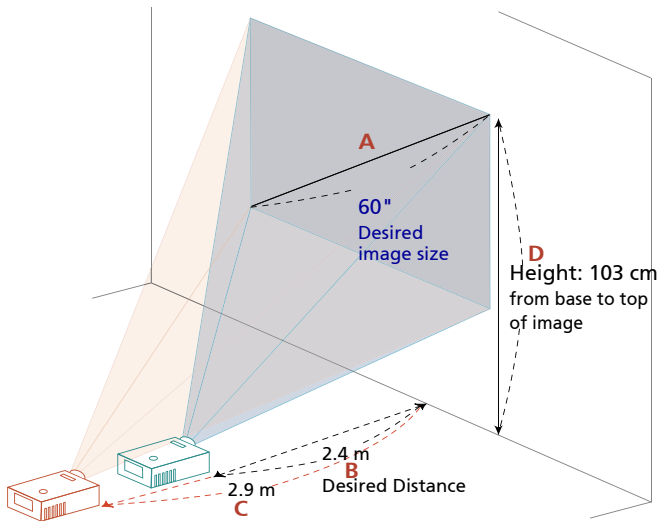

Desired Image Size		Distance (m)		Top (cm)
Diagonal (inch) <A>	W (cm) x H (cm)	Max zoom 	Min zoom <C>	From base to top of image <D>
40	81 x 61	1.6	1.9	70
50	102 x 76	2.0	2.4	86
60	122 x 91	2.4	2.9	103
70	142 x 107	2.8	3.4	119
80	163 x 122	3.2	3.9	135
90	183 x 137	3.6	4.3	151
100	203 x 152	4.0	4.8	168
120	244 x 183	4.8	5.8	200
150	305 x 229	6.1	7.3	249
200	406 x 305	8.1	9.7	330
250	508 x 381	10.2	12.2	411
300	610 x 457	12.2	14.6	493

Zoom Ratio: 1.2x

- XGA series

The table below shows how to achieve a desired image size by adjusting either the position or the zoom ring.

To obtain an image size of 60" set the projector at a distance 2.4 m and 2.8 m from the screen.

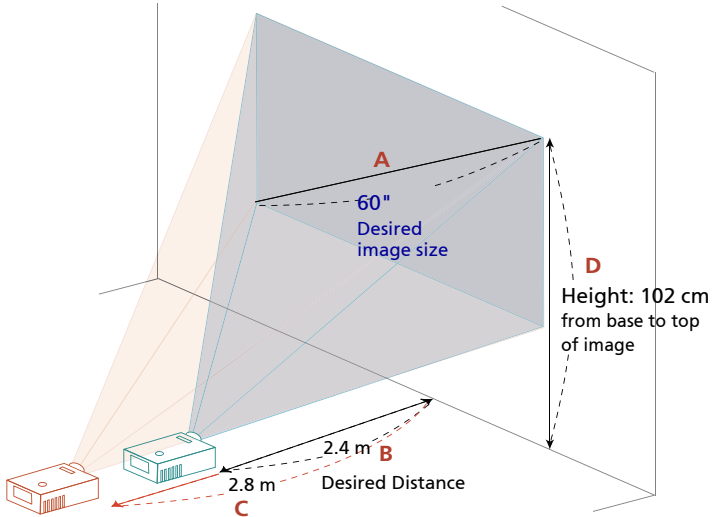

Desired Image Size		Distance (m)		Top (cm)
Diagonal (inch) <A>	W (cm) x H (cm)	Max zoom 	Min zoom <C>	From base to top of image <D>
40	81 x 61	1.6	1.9	70
50	102 x 76	2.0	2.4	86
60	122 x 91	2.4	2.8	102
70	142 x 107	2.8	3.3	118
80	163 x 122	3.2	3.8	134
90	183 x 137	3.6	4.3	151
100	203 x 152	4.0	4.8	167
120	244 x 183	4.8	5.7	199
150	305 x 229	6.0	7.2	248
200	406 x 305	8.0	9.6	328
250	508 x 381	10.1	12.0	409
300	610 x 457	12.1	14.5	490

Zoom Ratio: 1.2x

- WXGA series

The table below shows how to achieve a desired image size by adjusting either the position or the zoom ring.

To obtain an image size of 60" set the projector at a distance 2.0 m and 2.4 m from the screen.

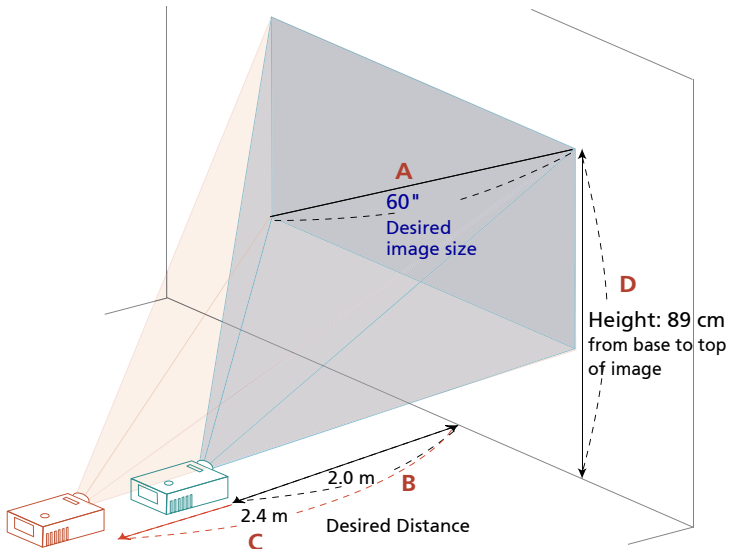

Desired Image Size		Distance (m)		Top (cm)
Diagonal (inch) <A>	W (cm) x H (cm)	Max zoom 	Min zoom <C>	From base to top of image <D>
40	86 x 54	1.3	1.6	61
50	108 x 67	1.7	2.0	75
60	129 x 81	2.0	2.4	89
70	151 x 94	2.3	2.8	103
80	172 x 108	2.7	3.2	117
90	194 x 121	3.0	3.6	131
100	215 x 135	3.4	4.0	145
120	258 x 162	4.0	4.9	173
150	323 x 202	5.1	6.1	215
200	431 x 269	6.8	8.2	285
250	538 x 337	8.5	10.2	355
300	646 x 404	10.2	12.3	424

Zoom Ratio: 1.2x

- 1080p series

The table below shows how to achieve a desired image size by adjusting either the position or the zoom ring.

To obtain an image size of 60" set the projector at a distance 1.8 m and 2.2 m from the screen.

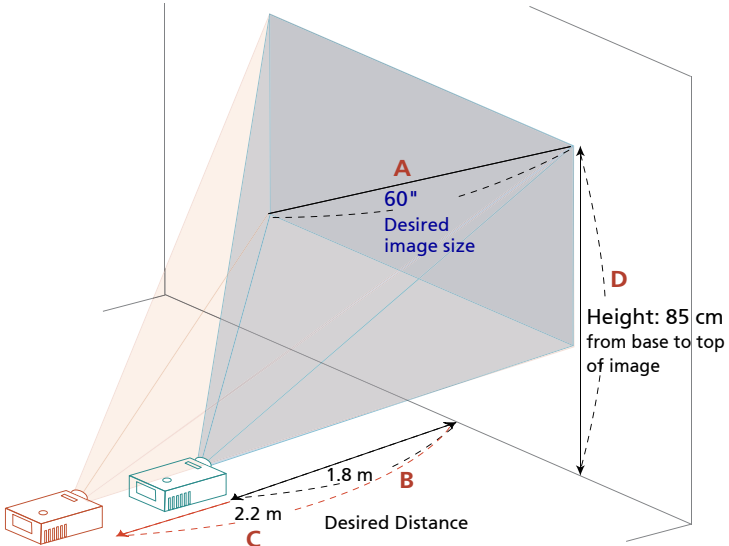

Desired Image Size		Distance (m)		Top (cm)
Diagonal (inch) <A>	W (cm) x H (cm)	Max zoom 	Min zoom <C>	From base to top of image <D>
40	89 x 50	1.2	1.5	58
50	111 x 62	1.5	1.8	72
60	133 x 75	1.8	2.2	85
70	155 x 87	2.1	2.6	98
80	177 x 100	2.4	3.0	112
90	199 x 112	2.7	3.3	125
100	221 x 125	3.1	3.7	138
120	266 x 149	3.7	4.5	165
150	332 x 187	4.6	5.6	205
200	443 x 249	6.2	7.5	271
250	553 x 311	7.7	9.4	338
300	664 x 374	9.3	11.2	404

Zoom Ratio: 1.2x

User Controls

Onscreen Display (OSD) Menus

The projector has multilingual OSD that allow you to make image adjustments and change a variety of settings.

Using the OSD menus

- To open the OSD menu, press **"MENU"** on the remote control.
- When the OSD is displayed, use the ◀ ▶ keys to select any item in the main menu. After selecting the desired main menu item, press ▼ to enter submenu for feature setting.
- Use the ▲ ▼ keys to select the desired item and adjust the settings by using the ◀ ▶ keys.
- Select the next item to be adjusted in the submenu and adjust as described above.
- Press **"BACK"** on the remote control, the screen will go back to the previous menu or exit OSD.
- Press **"MENU"** on the remote control to exit OSD directly. The OSD menu will close and the projector will automatically save the new settings.

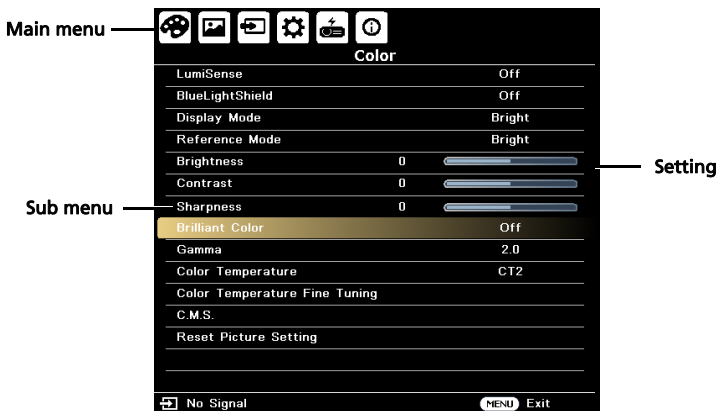

Note: Some of the following OSD settings may not be available. Please refer to the actual OSD of your projector.

Note: Functions vary depending on model definition.

Color

LumiSense	<p>The light sensor of LumiSense+ technology can intelligently optimize the brightness and color saturation of projected image based on actual ambient light. The feature greatly enhances dark detail visibility and color saturation.</p> <ul style="list-style-type: none"> • Off: For normal mode. (ambient light sensor is off) • Normal: Select "Normal" to meet the visual effect of dark detail enhancement. • Boost: Select "Boost" to meet the visual effect of brightness boost. • Dynamic Black: automatically optimize the display of dark movie scenes enabling them to be shown in incredible detail. <p><Note>: Once LumiSense is enabled, BlueLightShield switches to "Off". <Note>: Once Dynamic Black is enabled, ECO Mode is grayout.</p>
BlueLightShield	<ul style="list-style-type: none"> • Off: Default setting. • Low / Medium / High: Select Low / Medium / High to reduce different exposure levels of blue light dynamically. <p><Note>: Once BlueLightShield is enabled, LumiSense switches to "Off".</p>
Display Mode	<p>There are many factory presets optimized for various types of images.</p> <ul style="list-style-type: none"> • Bright: For brightness optimization. • Presentation: For meeting presentation. • Standard: For common environment. • Video: For playing video in a bright environment. • EcoPro: Dims the projector lamp to the very low status which will extend the lamp life to 20,000 hours. • User 1/User 2: Memorize user's settings. • 3D: Only available for 3D input signal. <p><Note>: Once EcoPro is enabled, ECO Mode switches to EcoPro at the same time. <Note>: After the above setting is done, if user changes to other Display mode settings rather than EcoPro, ECO Mode switches to "Off". <Note>: When EcoPro is enabled for 4 hours, the projector will switch to the power consumption of ECO mode for 10 minutes, and then switches back to EcoPro mode again. During the period time of ECO mode, the lamp will become brighter.</p>
Reference Mode	For user mode settings.
Brightness	<p>Adjust the brightness of the image.</p> <ul style="list-style-type: none"> • Press ◀ to darken the image. • Press ▶ to lighten the image.

Contrast	<p>"Contrast" controls the difference between the lightest and darkest parts of the picture. Adjusting the contrast changes the amount of black and white in the image.</p> <ul style="list-style-type: none"> • Press ◀ to decrease the contrast. • Press ▶ to increase the contrast.
Sharpness	<p>Adjusts the sharpness of the image.</p> <ul style="list-style-type: none"> • Press ◀ to decrease the sharpness. • Press ▶ to increase the sharpness.
Brilliant Color	Choose On to enable a greater brightness increase in mid-tone images.
Gamma	Effects the representation of dark scenery. With greater gamma value, dark scenery looks brighter.
Color Temperature	Use this function to choose CT1, CT2, CT3 mode.
Color Temperature Fine Tuning	R Gain Adjusts the red gain for color temperature optimization.
	G Gain Adjusts the green gain for color temperature optimization.
	B Gain Adjusts the blue gain for color temperature optimization.
	R Bias Adjusts the red bias for color temperature optimization.
	G Bias Adjusts the green bias for color temperature optimization.
	B Bias Adjusts the blue bias for color temperature optimization.
C.M.S.	Ind. Color Management Adjusts the red, green, blue, cyan, yellow and magenta colors.
	Ind. Hue Adjusts the color balance of red and green.
	Ind. Saturation Adjusts the selected color to be less or more saturated color.
	Ind. Gain Adjusts the selected color's contrast.
Reset Color Setting	Resets current or all display modes to the factory preset settings.



Note: Functions vary depending on model definition.

Image

Wall Color	Use this function to choose a proper color according to the wall. There are several choices, including white, light yellow, light blue, pink, dark green. It will compensate the color deviation due to the wall color to show the correct image tone.
Aspect Ratio	Use this function to choose your desired aspect ratio. <ul style="list-style-type: none"> • Auto: Keep the image with original width-high ratio and maximize the image to fit native horizontal or vertical pixels. • 4:3: The image will be scaled to fit the screen and displayed using a 4:3 ratio. • 16:9: The image will be scaled to fit the width of the screen and the height adjusted to display the image using a 16:9 ratio. • 16:10: The image will be scaled to fit the width of the screen and the height adjusted to display the image using a 16:10 ratio.
H./V. Keystone	H. Keystone Press the ◀ or ▶ button to adjust image distortion horizontally and makes a squarer image.
	V. Keystone Press the ▲ or ▼ button to adjust image distortion vertically and makes a squarer image.
4 Corner Correction	Press the "ENTER" button to enter 4 Corner Correction page. Press the ▲/▼/◀/▶ to select one of the four corners and then press the "ENTER" button. Press the ▲/▼ to adjust vertical position. Press the ◀/▶ to adjust horizontal position. Press BACK to select other corners. Repeat the same procedure with the positions for the corners.
Position	Horizontal Centers the on-screen image by moving it to the left or right. Vertical Centers the on-screen image by moving it up or down.
Phase	Synchronizes the signal timing of the projector with the graphics card. If you experience an unstable or flickering image, use this function to correct it.
Clock	Clock changes the projector's refresh rate to match the frequency of your computer's graphics card. If you can see a vertical flickering bar in the projected image, use this function to make the necessary adjustments.
Digital Zoom	Magnifies or reduces the projected image.
3D (Only available for 3D input signal.)	3D Mode If the 3D content is not displayed correctly, you can select a 3D format that suits the 3D content you are viewing and obtain the best result.
	3D L/R Invert If you see a discrete or overlapping image while wearing DLP 3D glasses, you may need to execute "Invert" to get best match of left/right image sequence to get the correct image (for DLP 3D).











Note: Functions vary depending on model definition.

Source

Source Selection	Manual by source menu, Auto by Smart Detection.
HDMI Color Range	<p>Adjust the color range of the HDMI image data to correct color display error.</p> <ul style="list-style-type: none"> • Auto: Automatically adjust by information from player. • Limited Range: Process the input image as limited color range data. • Full Range: Process the input image as full color range data.

Setting



Language	<p>Choose the multilingual OSD menu. Use the /// key to select your preferred menu language.</p> <ul style="list-style-type: none"> • Press "ENTER" to confirm the selection.
Projection Mode	<ul style="list-style-type: none"> •  Front: The factory default setting. •  Rear: When you select this function, the projector reverses the image so you can project from behind a translucent screen. •  Ceiling+Rear: When you select this function, the projector reverses and inverts the image at same time. You can project from behind a translucent screen with ceiling mounted projection. •  Ceiling+Front: When you select this function, the projector inverts the image for ceiling-mounted projection.
Menu Settings	<p>Menu Display Time Choose the OSD menu display time. (Default is 20 seconds). Select "Manual" to turn off main menu/one direct-key menu manually by user.</p>
	<p>Menu Position Sets the On-Screen Display (OSD) menu position.</p>
	<p>Reminder Message Sets whether to display the reminder message.</p>
Operation Settings	<p>AC Power On Choose "On" to power on projector while AC power plug in.</p>
	<p>Auto Shutdown The projector will automatically shutdown when there is no signal input after the allocated time. (default is 15 minutes)</p>
	<p>Quick Cooling Choose "On" to turn off the projector in a few seconds.</p>
Control Panel Lock	Disables or enables all panel key functions except Power on the projector.
Background	Allows you to select which background color will display when no signal is input into the projector.

Startup Screen	Use this function to select your desired startup screen. If you change the setting, the changes will take effect when you exit the OSD menu.
USB 5V (Standby)	Default is "Off". Choose "On" to supply 5V/1.5A power while in standby mode.
VGA OUT (Standby)	Default is "Off". Choose "On" to enable VGA OUT connection.
Firmware Upgrade	Choose to upgrade firmware via USB drive or network.



Note: Functions vary depending on model definition.

Management

High Altitude	Choose "On" to turn on High Altitude mode. Operate the fans at full speed continuously to allow for proper high altitude cooling of the projector.
Audio Settings	Volume <ul style="list-style-type: none"> • Press  to decrease the volume. • Press  to increase the volume.
	Power On/Off Select this function to adjust the notification volume when turning the projector on/off.
Lamp Settings	Lamp Information <ul style="list-style-type: none"> • Lamp Timer Displays the lamp's elapsed operating time (in hours) including Normal, Eco, and EcoPro. • Lamp Life Displays the percentage of the remaining lamp life.
	Lamp Hour Reset Press the " ENTER " button and choose "Yes" to turn the lamp hour counter to 0 hours.
ECO Mode	Choose "On" to dim the projector lamp which will lower power consumption, extend the lamp life and reduce noise. Choose "Off" to return normal mode. Choose "EcoPro" to dim the projector lamp to the very low status which will extend the lamp life to 20,000 hours.
Security Settings	Change Password To set or change password please follow up OSD on-screen steps. <Note> If you forget the password, contact your local reseller or service center to decode the number.
	Change Security <ul style="list-style-type: none"> • Power On Lock Choose to enter the password next time you turn on the projector. You will be asked to enter the current password before setting "On" or "Off".
Test Pattern	Choose "On" to enable the function and the projector displays the test pattern.

Network Settings	LAN IP / Mask Identify IP and Mask address.
	WiFi IP/Mask Identify IP and Mask address.
	MAC Address Identify MAC address.
	Wake on LAN (Standby) Set to "On" to enable wake-on-LAN function to power on projector via LAN under standby status. It is required to download WOL(wake-on-LAN; WOL) tool or app for PC/Mobile by users for this function.
	DHCP <ul style="list-style-type: none"> On: Projector will obtain an IP address automatically from your network. <Note> Grey out when LAN isn't plugged in and LAN IP X.X.X.X show 0.0.0.0
	LAN Reset Reset LAN function.
Reset	Press the " ENTER " button and choose "Yes" to return the parameters on all menus to the factory default settings.



.....

Note: Functions vary depending on model definition.

Information

Information	Display the projector information for Model Name, Input Source, Signal Type, Display Mode, Serial No. and Software Version screen.
-------------	--



.....

Note: Functions vary depending on model definition.

Acer LAN webpage management

How to login in

Make sure you projector connects to your device through a LAN cable and set DHCP to off in Network. Open browser and enter the Server IP address by 192.168.100.10 to find below homepage of acer LAN webpage management. A password is needed to login in before using. Default password of User is "0000".

The screenshot shows the Acer LAN webpage management interface. At the top right, there is a "Logout" button. Below it, a "System Status" header is visible. On the left side, there is a vertical menu with the following options: "System Status", "Change Password", "Projector Control", "Network Setup", and "Crestron". The main area contains a login form with two input fields: "User Name:" with the value "User" and "Password:" with a masked input. A "Log in" button is positioned to the right of the password field.

System Status

After login, main function pages will appear, i.e. **System Status**, **Change Password**, **Projector Control**, **Network Setting**, and **Crestron**.

System Status page is automatically selected after login.

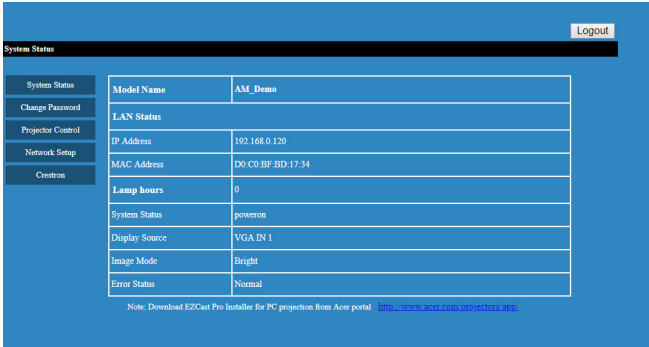

System Status	Model Name	AM_Demo
Change Password	LAN Status	
Projector Control	IP Address	192.168.0.120
Network Setup	MAC Address	D0:CO:BF:BD:17:34
Crestron	Lamp hours	0
	System Status	poweron
	Display Source	VGA IN 1
	Image Mode	Bright
	Error Status	Normal

Note: Download EZCast Pro installer for PC projection from Acer portal: <http://www.acer.com/projector/app/>



Download EZCast Pro Installer for PC projection from Acer portal <http://www.acer.com/projector/app/>

Change Password

Enduser can change the login password as wish.



System Status	Change Password for Webpage	
Change Password	Old password	<input type="password"/>
Projector Control	New password	<input type="password"/>
Network Setup	Confirm password	<input type="password"/>
Crestron		<input type="button" value="Apply"/>

Projector Control Panel

Enduser can control and adjust projector setting value via this page.

Network Setting

Enduser can set IP address as wish. After change network configurations, Network Setting on both webpage and projector will refresh automatically after press "Apply".

Crestron Setting (optional)

Enduser can change the settings for Crestron control system.

Appendices

Troubleshooting

If you experience a problem with your Acer projector, refer to the following troubleshooting guide. If the problem persists, please contact your local reseller or service center.

#	Problem	Solution
1	Start-up problems	<ul style="list-style-type: none"> • If no lights turn on: <ul style="list-style-type: none"> • Be sure that the power cord is securely connected to the projector and the other end is plugged into an outlet with power. • Press the power button again. • Unplug the power cord and wait for a short while, then plug it in and press the power button again.
2	Image problems	<ul style="list-style-type: none"> • If the searching source is displayed: <ul style="list-style-type: none"> • Press SOURCE to select an active input source. • Be sure the external source is turned on and connected. • For a computer connection, ensure your notebook computer's external video port is turned on. Refer to the computer manual. • If the image is out of focus: <ul style="list-style-type: none"> • While displaying the on-screen menu, adjust the focus ring. (The image size should not change; if it does, you are adjusting the zoom, not the focus.) • Check the projection lens to see if it needs cleaning. • If the image is flickering or unstable for a computer connection: <ul style="list-style-type: none"> • Press RESYNC.
3	Remote control problems	<ul style="list-style-type: none"> • If the remote control does not operate: <ul style="list-style-type: none"> • Be sure nothing is blocking the remote control receiver on the front of the projector. • Use the remote control within the effective range. <ul style="list-style-type: none"> • Aim the remote control at the screen or at the front of the projector. • Move the remote control so it is more directly in front of or behind the projector and not as far to the side.

LED & Alarm Definition Listing

LED Messages

Message	Power LED	Temp LED	Lamp LED
Stand-by mode	Orange	Off	Off
Powering up	Green flashing	Off	Off
Lamp retry	Green flashing	Off	Orange flashing
Normal operation	Green	Off	Off
Normal power-down cooling	Orange flashing	Off	Off
Lamp error in normal operation	Orange flashing	Off	Red
Lamp is not lit up	Orange flashing	Off	Orange flashing
The remaining time of lamp life becomes 5% or lower.	Green/Orange flashing	Off	Orange
Fan 1 (blower) error (the actual fan speed exceeds the desired speed)	Red	Red	Off
Fan 2 (air outlet) error (the actual fan speed exceeds the desired speed)	Red	Orange flashing	Off
Fan 3 (air inlet) error (the actual fan speed exceeds the desired speed)	Red	Green	Off
Temperature error (over limited temperature)	Green	Red	Off

Replacing the Lamp

Use a screwdriver to remove the screw(s) from the cover, and then pull out the lamp. Make sure the projector has been cooling down for at least 45 minutes before changing the lamp.



Warning: The lamp compartment is hot! Allow it to cool down before changing the lamp.

To Change the Lamp

Turn off the projector by pressing the Power button.

Allow the projector at least 45 minutes to cool down.

Disconnect the power cord.

- 1 Remove the screw (a) and slide the lamp cover (b) for removal.
- 2 Disconnect the lamp connector (c).
- 3 Remove the screw (d) that secure the lamp module.
Pull out the lamp module (e) by the handle (f).

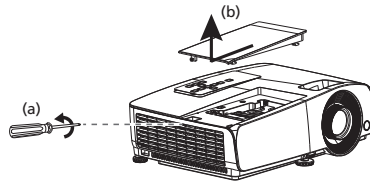

To replace the lamp module, use a new lamp and reverse the above steps.

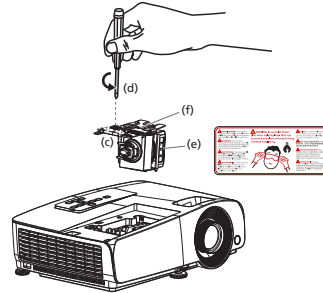

Warning: To reduce the risk of personal injury, do not drop the lamp module or touch the lamp bulb. The bulb may shatter and cause injury if it is dropped.

Ceiling Mount Installation

If you wish to install the projector using a ceiling mount, please refer to the steps below:

- 1 Drill four holes into a solid, structurally sound part of the ceiling, and secure the mount base.

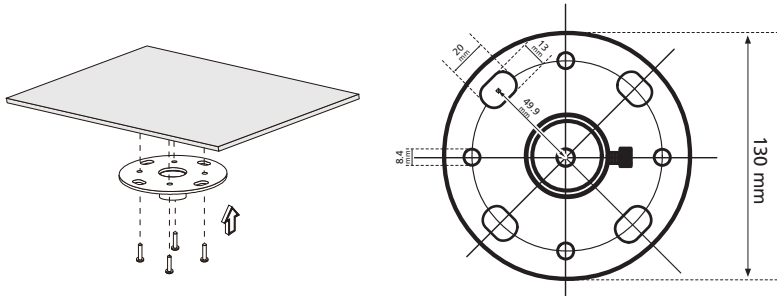

- 2 Choose the length combination based on actual environment. (CM-01S doesn't include Type 2 and Type 3.)

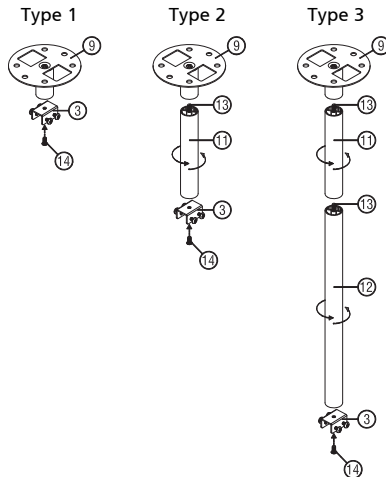

3 Type 1:

For the standard size use three bracket screws to mount the projector to the ceiling mount bracket.

Type 2 and Type 3:

Alternatively, for the larger size, use the sliding extensions for more supports.

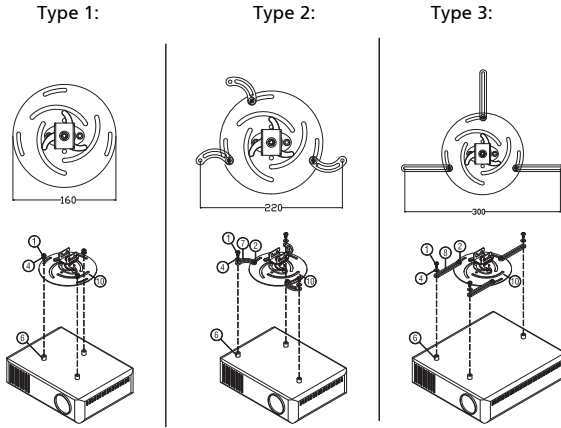

Note: It is recommended that you keep a reasonable space between the bracket and the projector to allow for proper heat distribution.

- 4 Connect the main body connector to the projector bracket (illustration 1), and then screw up four screws (illustration 2).

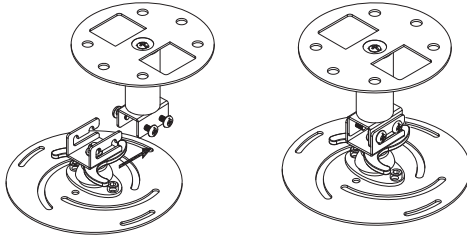

- 5 Adjust the angle and positioning as necessary.

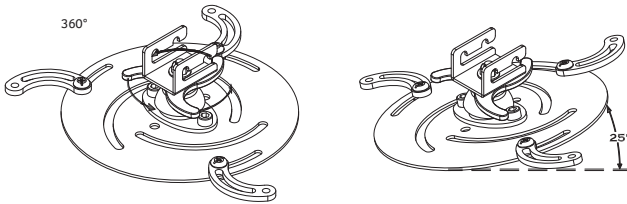

Note: The appropriate type of screw and washer for each model is listed in the table below. 4 mm diameter screws are enclosed in the screw pack.

Screw Type B		Washer Type	
Diameter (mm)	Length (mm)	Large	Small
4	25	V	V

SCREW SPEC. M4 x 25 mm

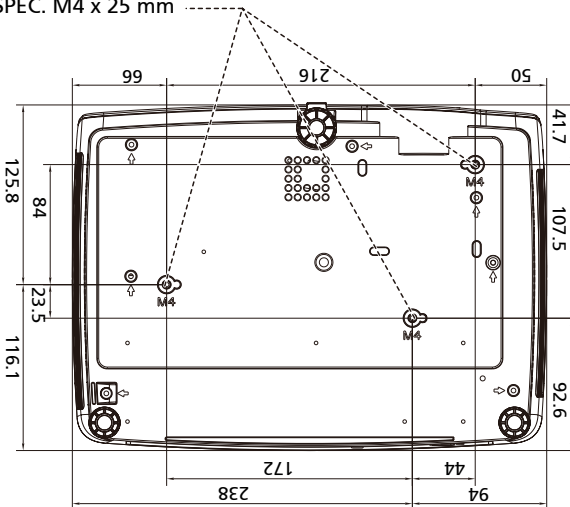

Specifications

The specifications listed below are subject to change without notice. For final specs, please refer to Acer's published marketing specifications.

Projection system	DLP®
Resolution	<ul style="list-style-type: none"> P1160Bi/D701Ei/EV-S71Ki/X1125Pi/DX131Ei/BS-031K/P1160BTi/FSV1904 series: Native 800 x 600 SVGA resolution P1260Bi/D711Ei/EV-X71Ki/X1225Pi/DX231Ei/BS-131K/P1260BTi/FNX1903 series: Native 1024 x 768 XGA resolution P1360WBi/D721Ei/EV-W71Ki/X1325WPi/DX431Ei/BS-331K/P1360WBTi/FWX1902 series: Native 1280 x 800 WXGA resolution P1560Bi/D751Ei/EV-F71Ki/X1525Pi/DX531Ei/BS-531K/P1560BTi/H6535Bi/H6535BTi/F1P1901 series: 1920x1080 1080p resolution
Computer compatibility	IBM PC and compatibles, Apple Macintosh, iMac and VESA standards: SXGA, XGA, VGA, SVGA, SXGA+, WXGA, WXGA+, WSXGA +
Video compatibility	HDTV (720p, 1080i, 1080p), EDTV (480p, 576p), SDTV (480i, 576i)
Aspect ratio	Auto, 4:3, 16:9, 16:10
Displayable colors	1.07 billion colors
Projection lens	<ul style="list-style-type: none"> P1160Bi/D701Ei/EV-S71Ki/X1125Pi/DX131Ei/BS-031K/P1160BTi/FSV1904/P1260Bi/D711Ei/EV-X71Ki/X1225Pi/DX231Ei/BS-131K/P1260BTi/FNX1903/P1360WBi/D721Ei/EV-W71Ki/X1325WPi/DX431Ei/BS-331K/P1360WBTi/FWX1902 series: F = 2.42 ~ 2.62, f = 22~25.79 mm, 1.2X manual zoom and manual focus P1560Bi/D751Ei/EV-F71Ki/X1525Pi/DX531Ei/BS-531K/P1560BTi/H6535Bi/H6535BTi/F1P1901 series: F = 2.47 ~ 2.66, f = 20.4 ~24.48 mm, 1.2X manual zoom and manual focus
Projection screen size (diagonal)	40" (102 cm) ~ 300" (762 cm)
Projection distance	<ul style="list-style-type: none"> P1160Bi/D701Ei/EV-S71Ki/X1125Pi/DX131Ei/BS-031K/P1160BTi/FSV1904/P1260Bi/D711Ei/EV-X71Ki/X1225Pi/DX231Ei/BS-131K/P1260BTi/FNX1903 series: 3.3' (1.0 m) ~ 39.7' (12.1 m) P1360WBi/D721Ei/EV-W71Ki/X1325WPi/DX431Ei/BS-331K/P1360WBTi/FWX1902 series: 3.3' (1.0 m) ~ 33.5' (10.2 m) P1560Bi/D751Ei/EV-F71Ki/X1525Pi/DX531Ei/BS-531K/P1560BTi/H6535Bi/H6535BTi/F1P1901 series: 3.3' (1.0 m) ~ 30.5' (9.3 m)

Throw ratio	<ul style="list-style-type: none"> • P1160Bi/D701Ei/EV-571Ki/X1125Pi/DX131Ei/BS-031K/P1160BTi/FSV1904/P1260Bi/D711Ei/EV-X71Ki/X1225Pi/DX231Ei/BS-131K/P1260BTi/FNX1903 series: 50"@2 m (1.94 ~ 2.33) • P1360WBi/D721Ei/EV-W71Ki/X1325WPi/DX431Ei/BS-331K/P1360WBTi/FWX1902 series: 60"@2 m (1.55 ~ 1.87) • P1560Bi/D751Ei/EV-F71Ki/X1525Pi/DX531Ei/BS-531K/P1560BTi/H6535Bi/H6535BTi/F1P1901 series: 66"@2 m (1.37 ~ 1.66)
Horizontal scan rate	15 - 90 kHz
Vertical refresh scan rate	24, 50 - 85 Hz
Lamp type	210W user-replaceable lamp
Keystone correction	±30 degrees
Weight	2.6 Kg (5.74 lbs)
Dimensions (W x D x H)	332 mm X 244 mm X 108 mm (13.1" x 9.6" x 4.3")
Digital Zoom	1.8X
Power supply	AC input 100 - 240 V auto-switching power supply
Power consumption	Normal mode: 270W ± 10% @ 110VAC ECO mode: 230W ± 10% @ 110VAC EcoPro mode: 166W ± 10% @ 110VAC Standby mode < 0.5W Network standby mode: <3W
Operating temperature	0°C to 40°C / 32°F to 104°F
Standard package contents	<ul style="list-style-type: none"> • AC power cord x1 • Remote control x1 • Battery x2 (for remote control) • Quick start guide (Projector) x1 • Quick start guide (Media/Wireless function) x1 • WirelessProjection-Kit x1 (option) • CastMaster-Kit x1 (option)
I/O connectors	<ul style="list-style-type: none"> • Power socket • VGA IN 1 x 1 • VGA output x 1 • RS232 x 1 • 3.5 mm audio jack output x 1 • 3.5 mm audio jack input x 1 • Mini USB x1 (for firmware upgrade) • USB type A x1 (5V/1.5A power supply) • USB type A x1 (wireless dongle) • HDMI x 2 • RJ45 LAN input x 1



Note: Design and specifications are subject to change without notice.

Compatibility modes

A. Computer

- Multiple signal support
 - Horizontal Frequency: 15-90 kHz,
Vertical Frequency: 24, 50-85 Hz,
Pixel Clock: 12-162 MHz

Mode	Resolution		Vertical frequency (Hz)	Horizontal frequency (kHz)	Analog Support	Digital Support
PC	VGA	640x480	60.0	31.47	✓	✓
			72.0	67.86	✓	✓
			75.0	37.50	✓	✓
			85.0	43.27	✓	
	SVGA	800x600	60.0	37.88	✓	✓
			72.0	48.08	✓	✓
			75.0	46.88	✓	✓
			85.0	56.67	✓	
	XGA	1024x768	60.0	48.36	✓	✓
			70.0	56.48	✓	✓
			75.0	60.02	✓	✓
			85.0	68.67	✓	
	WXGA	1280x720	60.0	44.80	✓	✓
		1280x768	60.0	47.78	✓	✓
		1280x800	60.0	49.60	✓	✓
		1360x768	60.0	47.71	✓	✓
	WXGA+	1440x900	60.0	55.90	✓	
	SXGA	1152x864	75.0	67.50	✓	
		1280x1024	60.0	63.98	✓	✓
			75.0	79.98	✓	✓
		1280x960	60.0	60.00	✓	✓
	SXGA+	1400x1050	60.0	65.32	✓	✓
	WSXGA+	1680x1050	60.0	60.30	✓	
		1920x1080	60.0	67.50	✓	✓
UXGA	1600x1200	60.0	75.00	✓		

B. DTV

Mode	Signal		Vertical frequency (Hz)	Horizontal frequency (kHz)	Analog Support	Digital Support
DTV Signal	480P	720x480p	59.9	31.50	✓	✓
	576P	720x576p	50.0	31.60	✓	✓
	720P	1280x720p	60.0	45.00	✓	✓
			50.0	37.50	✓	✓
	1080P	1920x1080p	24.0	27.00		✓
			60.0	67.50	✓	✓
			50.0	56.30	✓	✓



Note 1: Functions vary depending on model definition.

Note 2: 480i/576i/1080i interlaced signals are not supported.

Regulations and safety notices

FCC notice

This device has been tested and found to comply with the limits for a Class B digital device pursuant to Part 15 of the FCC rules. These limits are designed to provide reasonable protection against harmful interference in a residential installation. This device generates, uses, and can radiate radio frequency energy and, if not installed and used in accordance with the instructions, may cause harmful interference to radio communications.

However, there is no guarantee that interference will not occur in a particular installation. If this device does cause harmful interference to radio or television reception, which can be determined by turning the device off and on, the user is encouraged to try to correct the interference by one or more of the following measures:

- Reorient or relocate the receiving antenna.
- Increase the separation between the device and receiver.
- Connect the device into an outlet on a circuit different from that to which the receiver is connected.
- Consult the dealer or an experienced radio/television technician for help.

Notice: Shielded cables

All connections to other computing devices must be made using shielded cables to maintain compliance with FCC regulations.

Notice: Peripheral devices

Only peripherals (input/output devices, terminals, printers, etc.) certified to comply with the Class B limits may be attached to this equipment. Operation with non-certified peripherals is likely to result in interference to radio and TV reception.

Caution

Changes or modifications not expressly approved by the manufacturer could void the user's authority, which is granted by the Federal Communications Commission, to operate this device.

Operation conditions

This device complies with Part 15 of the FCC Rules. Operation is subject to the following two conditions: (1) this device may not cause harmful interference, and (2) this device must accept any interference received, including interference that may cause undesired operation.

Notice: Canadian users

This Class B digital apparatus complies with Canadian ICES-003.

Remarque à l'intention des utilisateurs canadiens

Cet appareil numérique de la classe B est conforme à la norme NMB-003 du Canada.

Compliant with Russian regulatory certification



Radio device regulatory notice



Note: The regulatory information below is for models with wireless LAN and/or Bluetooth only.

General

This product complies with the radio frequency and safety standards of any country or region in which it has been approved for wireless use. Depending on configurations, this product may or may not contain wireless radio devices (such as wireless LAN and/or Bluetooth modules).

Canada — Low-power license-exempt radio communication devices (RSS-247)

- a Common information
 - Operation is subject to the following two conditions:
 1. This device may not cause interference, and
 2. This device must accept any interference, including interference that may cause undesired operation of the device.
- b Operation in 2.4 GHz band
 - To prevent radio interference to the licensed service, this device is intended to be operated indoors and installation outdoors is subject to licensing.

List of applicable countries

This device must be used in strict accordance with the regulations and constraints in the country of use. For further information, please contact the local office in the country of use. Please see <http://ec.europa.eu/enterprise/rtte/implem.htm> for the latest country list.



Acer Incorporated
8F, 88, Sec. 1, Xintai 5th Rd., Xizhi
New Taipei City 221, Taiwan

Declaration of Conformity

We,

Acer Incorporated

8F, 88, Sec. 1, Xintai 5th Rd., Xizhi, New Taipei City 221, Taiwan

And,

Acer Italy s.r.l.

Via Lepetit, 40, 20020 Lainate (MI) Italy
Tel: +39-02-939-921 ,Fax: +39-02 9399-2913
www.acer.it

Product: DLP Projector
Trade Name: Acer
Model Number: F1P1901/ FWX1902/ FNX1903/ FSV1904
Marketing Name: P1560Bi/D751Ei/EV-F71Ki/X1525Pi/DX531Ei/
BS-531K/P1560BTi/H6535Bi/H6535BTi/ P1360WBt/D721Ei/
EV-W71Ki/X1325WPi/DX431Ei/BS-331K/P1360WBt/ P1260Bi/
D711Ei/EV-X71Ki/X1225Pi/DX231Ei/BS-131K/P1260BTi/
P1160Bi/D701Ei/EV-S71Ki/X1125Pi/DX131Ei/BS-031K/P1160BTi

We, Acer Incorporated, hereby declare under our sole responsibility that the product described above is in conformity with the relevant Union harmonization legislations: Directive 2014/53/EU on Radio Equipment, RoHS Directive 2011/65/EU and ErP Directive 2009/125/EC. The following harmonized standards and/or other relevant standards have been applied:

Electromagnetic compatibility

EN 55032:2015+AC:2016, Class B EN 61000-3-2:2014 Class D
 EN 55024:2010+A1:2015 EN 61000-3-3:2013

Radio frequency spectrum usage

EN 301 489-1 V2.1.1 EN 301 489-17 V3.1.1 EN 62311:2008

Healthy and Safety

EN 60950-1:2006/A11:2009/A1:2010/A12:2011/A2:2013

RoHS

EN 50581:2012

ErP

Regulation (EC) No. 1275/ 2008; EN 50564:2011 Regulation (EC) No. 278/2009; EN 50563:2011

This radio equipment operates with the following frequency bands and maximum radio-frequency power:

Frequency bands	GSM		UMTS	LTE	Bluetooth	WLAN	
	850/900	1800/1900				5GHz	2.4GHz
Maximum radio-frequency power	2W	1W	0.25W	0.2W	<20dBm	<23dBm	<20dBm

Year to begin affixing CE marking 2018.

RU Jan / Sr. Manager
Acer Incorporated (Taipei, Taiwan)

Jan. 20, 2020
Date



Acer America Corporation
333 West San Carlos St.,
Suite 1500
San Jose, CA 95110
U. S. A.
Tel: 254-298-4000
Fax: 254-298-4147
www.acer.com



Federal Communications Commission Declaration of Conformity

This equipment complies with part 15 of the FCC Rules. Operation is subject to the following two conditions:

- (1) This equipment may not cause harmful interference, and
- (2) This equipment must accept any interference received, including interference that may cause undesired operation.

The following local Manufacturer / Importer is responsible for this declaration:

Product:	DLP Projector
Model Number:	F1P1901/ FWX1902/ FNX1903/ FSV1904
Machine Type:	P1560Bi/D751Ei/EV-F71Ki/X1525Pi/DX531Ei/ BS-531K/P1560BTi/H6535Bi/H6535BTi/ P1360WBi/D721Ei/EV-W71Ki/X1325WPi/ DX431Ei/BS-331K/P1360WBTi/ P1260Bi/D711Ei/EV-X71Ki/X1225Pi/DX231Ei/ BS-131K/P1260BTi/ P1160Bi/D701Ei/EV-S71Ki/X1125Pi/DX131Ei/ BS-031K/P1160BTi
Name of Responsible Party:	Acer America Corporation
Address of Responsible Party:	333 West San Carlos St. Suite 1500 San Jose, CA 95110 U. S. A.
Contact Person:	Acer Representative
Phone No.:	254-298-4000
Fax No.:	254-298-4147